SHANGHAI XANNIX LIGHTING CO.,LTD

5th Floor, No. 358 Youdong Road
Minhang District, Shanghai, China

Tel:86-15800714612

Email:sales@xanled.com joyce@xanled.com

Web:www.xanled.com

Factory Address:439 Huanzhen West Road,
Xincheng, Xiuzhou District, Jiaxing, Zhejiang, China

RELIABLE LIGHTING AS STANDARD

XANNIX



XANNIX



Contents

Table Lamp

06	Jammi
08	Helga
10	Vogue
12	Haley
14	Bruce
16	Mega
18	Gloria
20	Jessica
22	Grace
24	Mushroom
26	Laura

Solar Table Lamp

30	Jelly
32	Moji
34	Lexon
36	Greta
38	Sunning
40	Sardinia
42	Norai
44	Luceo
46	Stella
48	Chloe

Table Lamp



Grace



Helga



Bruce

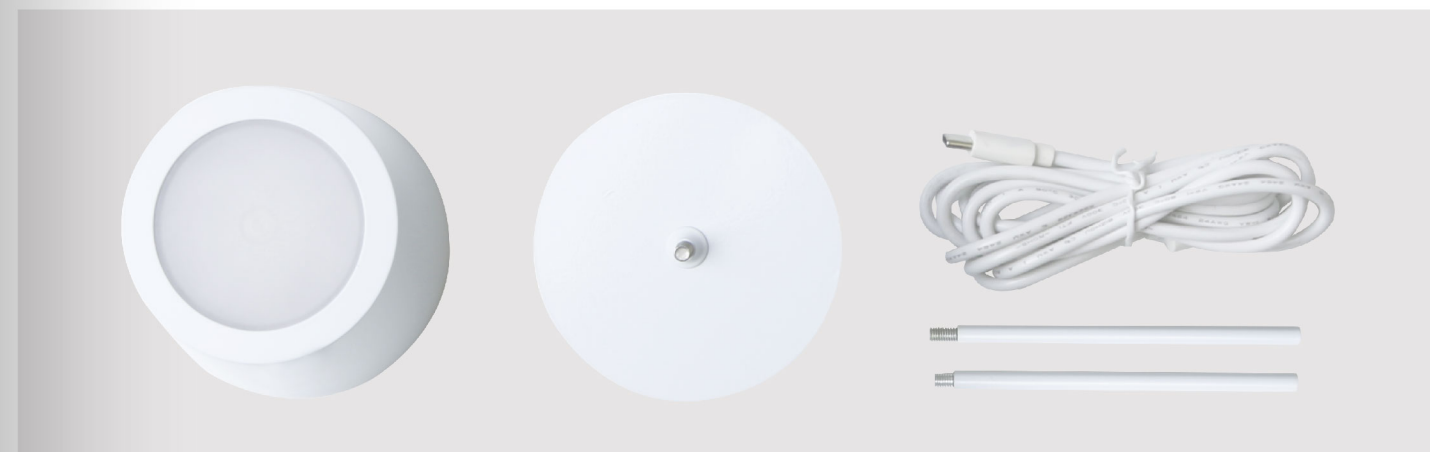

Features:

- Eco-friendly, Li-on battery could be replaced and the lamp can recycle
- 3-step dimmable touch dimming
- Knock Down Packing smart and space-saving. Inner box size only 13.5*12.5*12.5cm!



Watt	Input	Kelvin	lm	Ra	Battery	IP Rating	Size
3.1W	5V/1A	3000k	250	80	3.7V/2000mAh	IP44	Φ110*260/350MM



Features:

- Eco-friendly, Li-on battery could be replaced and the lamp can recycle
- Stepless dimmable touch dimming
- Aluminium shade + Acrylic top+ metal base



Watt	Input	Kelvin	lm	Ra	Battery	IP Rating	Size
3.5W	5V/1A	3000k	270	80	3.7V/5200mAh	IP44	ø100x380MM

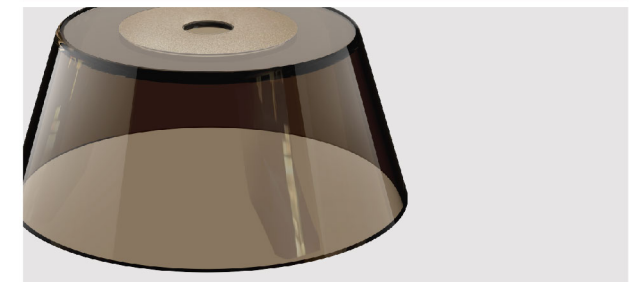
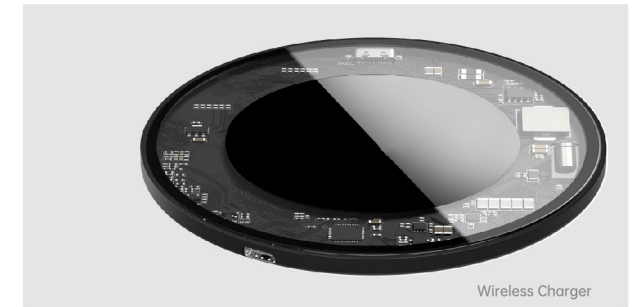

Features:

- Eco-friendly, with LiFePO4 high-end battery,could be replaced and the lamp can recycle
- Stepless dimmable touch dimming
- Two optional lampshades



Watt	Input	Kelvin	lm	Ra	Battery	IP Rating	Size
1.9W	5V/1A	3000k	140	95	3.2V/ 6000mAh	IP44	Ø125*285MM



Features:

- Eco-friendly, Li-on battery could be replaced and the lamp can recycle
- 3 color temperature selectable + stepless dimmable touch dimming
- Portable table lamp with touch switch operation on the top
- Charged with Type-C cable



Watt	Input	Kelvin	lm	Ra	Battery	IP Rating	Size
2.1W	5V/1A	3000k	160	80	3.7V/3600mAh	IP40	ø120x320MM



- Features:
- Eco-friendly, Li-on battery could be replaced and the lamp can recycle.
 - 3-step dimmable touch dimming.
 - Portable table lamp with touch switch on the base.



Watt	Input	Kelvin	lm	Ra	Battery	IP Rating	Size
3W	5V/1A	3000k	400	80	3.7V/4400mAh	IP44	Ø136*250/350MM



Features:

- It is made of green non-polluting materials, environmentally friendly, safe and pollution-free.
- Using high-brightness LED lamp beads, Ra>80, SDCM<6, no UV radiation.
- 3000K soft light, segmented dimming.
- Indoor and outdoor use, protection grade Ip44.
- Built-in lithium battery 3.7V 2000mAh, which can be recharged and used repeatedly.
- Three-level touch dimming, eye protection, comfortable and bright, warm and loving, and easily illuminate every corner.



Watt	Input	Kelvin	lm	Ra	Battery	IP Rating	Size
2W	5V/1A	CCT	200	80	3.7V/2*1800mAh	IP44	Φ160*145*250MM



Features:

- Eco-friendly, Li-on battery could be replaced and the lamp can recycle
- 3000K soft light, three gear dimming.
- Portable table lamp with elegant appearance.
- Charged with Type-C cable.



Watt	Input	Kelvin	lm	Ra	Battery	IP Rating	Size
2W	5V/1A	2700k	160	80	3.2v/1800mAh	IP44	∅130*280mm



Features:

- Made of green and pollution-free materials, environmentally friendly, safe and pollution-free. Adopting high brightness LED light beads.
- 3000K soft light, three gear dimming.
- Indoor and outdoor use, with a protection level of Ip44.
- Built-in lithium battery 3.7V 2000mAh, can be repeatedly charged and reused.
- Unrestricted and mobile to meet the needs of different locations.



Watt	Input	Kelvin	lm	Ra	Ra	IP Rating	Size
2.5W	5V/1A	3000k		80	3.7v/2000mAh	IP44	φ160*218MM



Features:

- Made of green and pollution-free materials, environmentally friendly, safe and pollution-free.
- Adopting high brightness LED light beads.
- 3000K soft light three gear dimming.
- Indoor and outdoor use, with a protection level of IP44
- Built-in lithium battery 3.7V 2000mAh, can be repeatedly charged and reused.
- Unrestricted and mobile to meet the needs of different locations



Watt	Input	Kelvin	lm	Ra	Battery	IP Rating	Size
3W	5V/1A	3000k	270	80	3.7V/2000mAh	IP44	Φ125*Φ84*210MM



Features:

- It is made of green non-polluting materials, environmentally friendly, safe and pollution-free.
- Using high-brightness LED lamp beads, Ra>80, SDCM<6, no UV radiation.
- 3000K soft light, segmented dimming.
- Indoor and outdoor use, protection grade Ip44.
- Built-in lithium battery 3.7V 2000mAh, which can be recharged and used repeatedly.
- Three-level touch dimming, eye protection, comfortable and bright, warm and loving, and easily illuminate every corner.

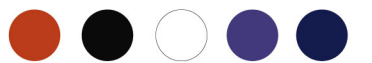

Watt	Input	Kelvin	lm	Ra	Battery	IP Rating	Size
2.5W	5V/1A	3000k		80	3.7v/2000mAh	IP44	Φ160*218MM



Features:

- It is made of green non-polluting materials, environmentally friendly, safe and pollution-free. 3000K soft light, three gear dimming.
- Using high-brightness LED lamp beads, Ra>80, SDCM<6, no UV radiation.
- 3000K soft light, segmented dimming.
- indoor and outdoor use, protection grade Ip44.
- Built-in lithium battery 3.7V 2000mAh, which can be recharged and used repeatedly.
- Three-level touch dimming, eye protection, comfortable and bright, warm and loving, and easily illuminate every corner.

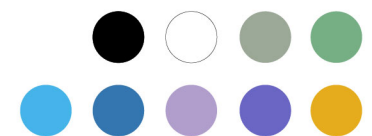

Watt	Input	Kelvin	lm	Ra	Battery	IP Rating	Size
2.5W	5V/1A	3000k	300	80	3.2v/3600mAh	IP44	130*130*320MM

Solar Solution



Greta



Sunning



Stella



Features:

- Eco-friendly, Li-on battery could be replaced and the lamp can recycle
- Stepless dimmable touch dimming
- Could be charged with both solar and USB cable

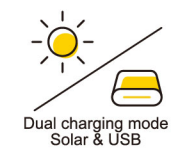

Watt	Input	Kelvin	lm	Ra	Battery	IP Rating	Size
4W	5V/1A	3000k	200	80	3.7V/3600mAh	IP44	φ130*380MM



Features:

- Eco-friendly, Li-on battery could be replaced and the lamp can recycle
- Stepless dimmable touch dimming
- Could be charged with both solar and USB cable

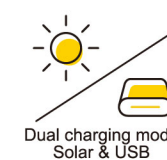

Watt	Input	Kelvin	lm	Ra	Battery	IP Rating	Size
5W	5V/1A	4000k	450	80	3.7V/2000mAh	IP54	Φ120*320MM

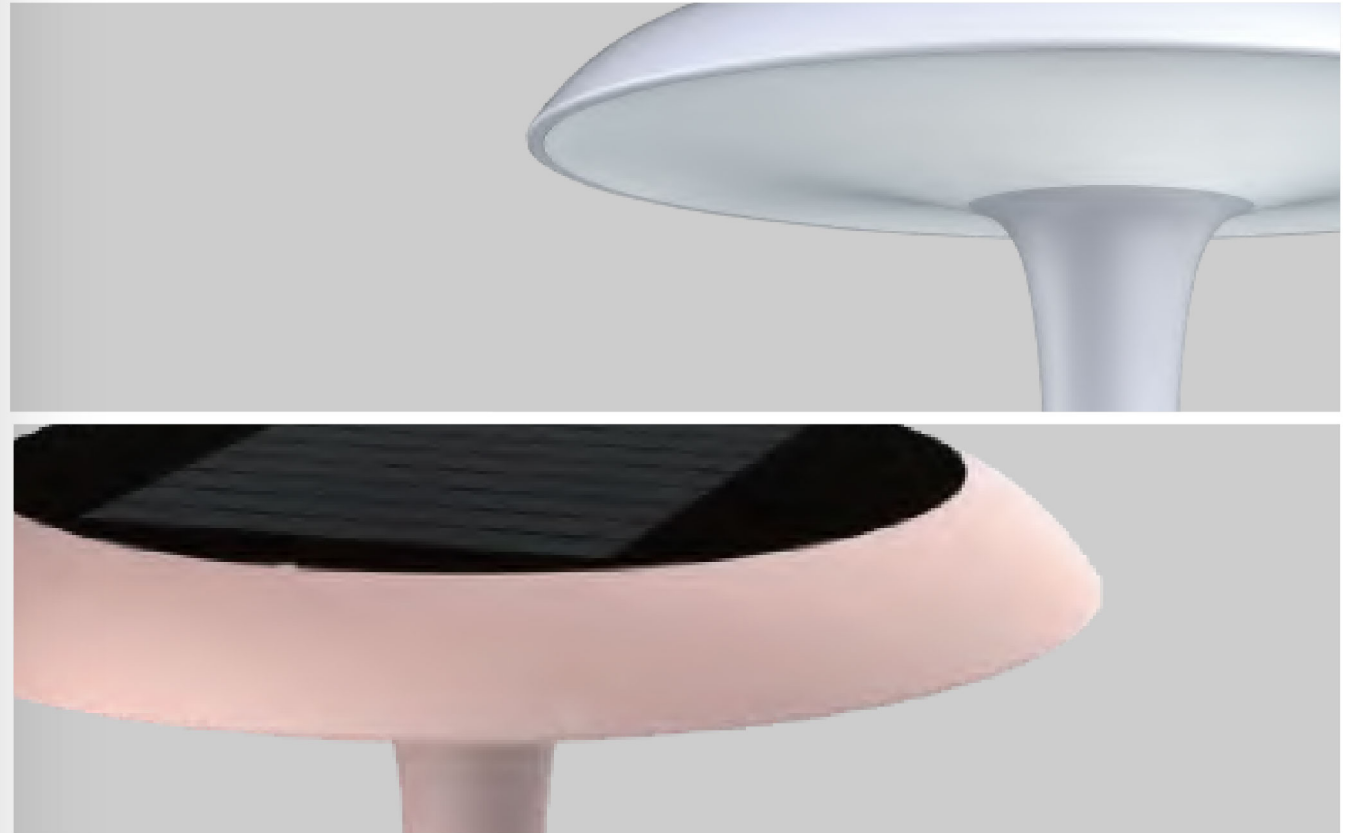

Touch Button

Features:

- Eco-friendly, Li-on battery could be replaced and the lamp can recycle
- Stepless dimmable touch dimming
- Could be charged with both solar and USB cable

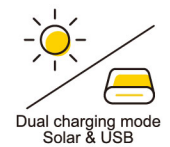

Watt	Input	Kelvin	lm	Ra	Battery	IP Rating	Size
5W	5V/1A	4000k	450	80	3.7V/2000mAh	IP54	Φ187*196.8MM



Features:

- Eco-friendly, Li-on battery could be replaced and the lamp can recycle
- Stepless dimmable touch dimming
- Could be charged with both solar and USB cable

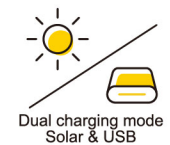

Watt	Input	Kelvin	lm	Ra	Battery	IP Rating	Size
2W	5V/1A	3000k	150	80	3.7V/1800mAh	IP44	Ø157*370MM

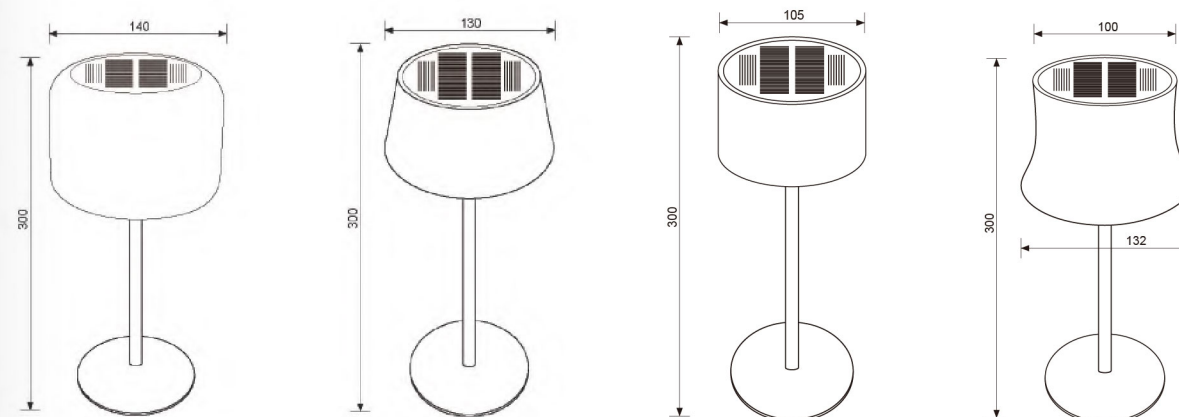

Features:

- Eco-friendly, Li-on battery could be replaced and the lamp can recycle
- 3-step dimmable touch dimming
- Could be charged with both solar and USB cable

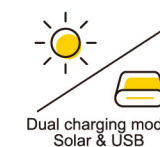

Watt	Input	Kelvin	lm	Ra	Battery	IP Rating
2.5W	5V/1A	3000k	200	80	3.7V/2200mAh	IP44



Features:

- Eco-friendly, Li-on battery could be replaced and the lamp can recycle
- Stepless dimmable touch dimming
- Could be charged with both solar and USB cable

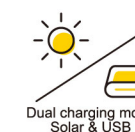

Watt	Input	Kelvin	lm	Ra	Battery	IP Rating	Size
2W	5V/1A	2700k	160	80	3.7V/2200mAh	IP 44	∅110*264MM



Features:

- Eco-friendly, Li-on battery could be replaced and the lamp can recycle
- Stepless dimmable touch dimming
- Could be charged with both solar and USB cable

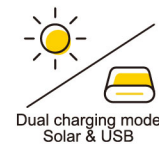

Watt	Input	Kelvin	lm	Ra	Battery	IP Rating	Size
2W	5V/1A	2700k	160	80	3.7V/1200mAh	IP44	Φ115*203MM



The handle can be the same color as the lamp body.

Features:

- Eco-friendly, Li-on battery could be replaced and the lamp can recycle
- Stepless dimmable touch dimming
- Could be charged with both solar and USB cable

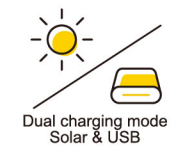

Watt	Input	Kelvin	lm	Ra	Battery	IP Rating	Size
2W	5V/1A	2700k	160	80	3.7V/1200mAh	IP44	φ108*71MM



Features:

- Eco-friendly, Li-on battery could be replaced and the lamp can recycle
- Stepless dimmable touch dimming
- Could be charged with both solar and USB cable

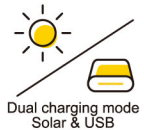

Watt	Input	Kelvin	lm	Ra	Battery	IP Rating	Size
2W	5V/1A	2700k	160	80	3.7V/1200mAh	IP44	Ø152*260MM



Features:

- Eco-friendly, Li-on battery could be replaced and the lamp can recycle
- Stepless dimmable touch dimming
- Could be charged with both solar and USB cable

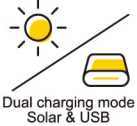

Watt	Input	Kelvin	lm	Ra	Battery	IP Rating	Size
2W	5V/1A	2700k	160	80	3.7V/1200mAh	IP44	Ø130*200MM